

Features

- Standard designs
- Screw Spline assembly
- Used with Trifab® VersaGlaze® 451/451T
 - Shear Block - 2" vertical mullion, center glazed
- Used with Trifab® VersaGlaze® 451/451T/451UT/601/601T/601UT
 - Screw Spline - 2-1/4" vertical mullion, center glazed
- Helps reduce building energy consumption
- Permanodic® anodized finishes option
- Painted finishes in standard and custom choices
- Shading performance can be analyzed by Solector® Sun Shading Estimator Tool

For specific product applications,
consult your Kawneer representative.

Laws and building and safety codes governing the design and use of Kawneer products, such as glazed entrance, window, and curtain wall products, vary widely. Kawneer does not control the selection of product configurations, operating hardware, or glazing materials, and assumes no responsibility therefor.

Kawneer reserves the right to change configuration without prior notice when deemed necessary for product improvement.
© 2013, Kawneer Company, Inc.

Architects - Most extrusions illustrated in this catalog are standard products for Kawneer. These concepts have been expanded and modified to afford you design freedom. Some miscellaneous details are non-standard and are intended to demonstrate how the system can be modified to expand design flexibility. Please contact your Kawneer representative for further assistance.

TRIFAB® VG 451/451T FRAMING
 - Shear Block Assembly4

TRIFAB® VG 451/451T/451UT FRAMING
 - Screw Spline Assembly5

TRIFAB® 601/601T/601UT FRAMING
 - Screw Spline Assembly6

SUNSHADE COMBINATIONS7, 8

DESIGN GUIDELINES.....9

Laws and building and safety codes governing the design and use of Kawneer products, such as glazed entrance, window, and curtain wall products, vary widely. Kawneer does not control the selection of product configurations, operating hardware, or glazing materials, and assumes no responsibility therefor.

Kawneer reserves the right to change configuration without prior notice when deemed necessary for product improvement.
© 2013, Kawneer Company, Inc.

Metric (SI) conversion figures are included throughout these details for reference. Numbers in parentheses () are millimeters unless otherwise noted.

The following metric (SI) units are found in these details:

- m – meter
- cm – centimeter
- mm – millimeter
- s – second
- Pa – pascal
- MPa – megapascal

NOTE: For standard storefront applications the outrigger is limited to 30".
 Details shown with 30" square outrigger, arch blade and rectangular fascia.

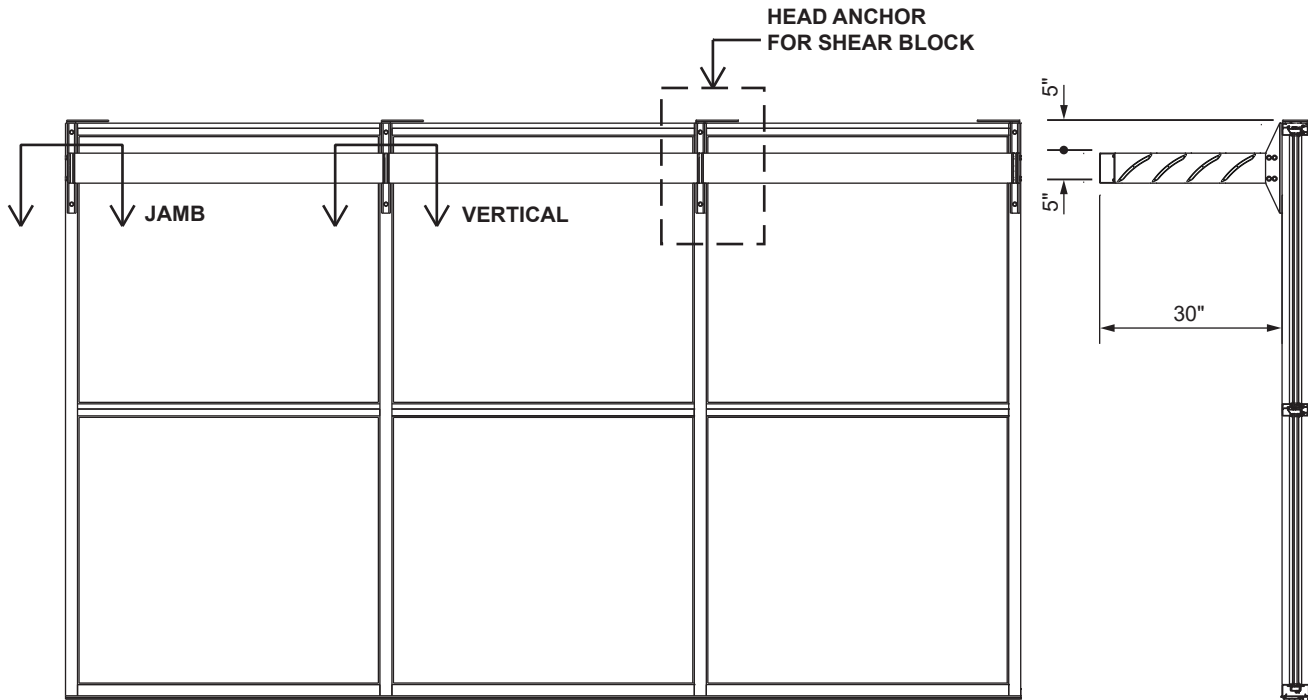

NOTE:
 Horizontal SunShades are not recommended directly over entrances and walkways to eliminate any risk of injury due to falling ice or snow.

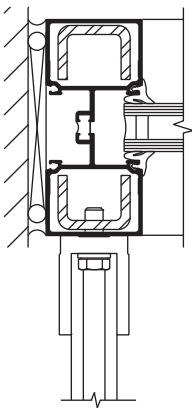

**TRIFAB® VG 451T
 JAMB
 (TF VG 451 SIMILAR)**

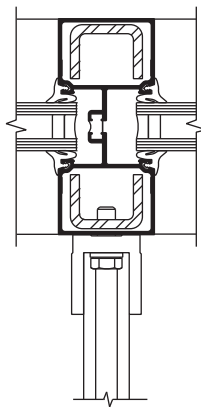

**451T
 VERTICAL**

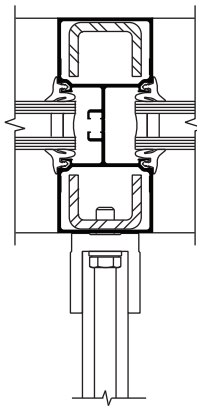

**451
 VERTICAL**

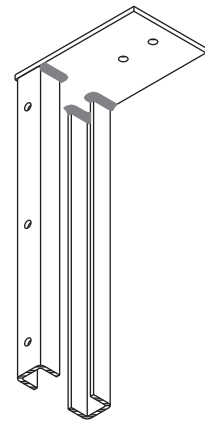

**HEAD ANCHOR
 FOR SHEAR BLOCK
 FRAMING**

Laws and building and safety codes governing the design and use of Kawneer products, such as glazed entrance, window, and curtain wall products, vary widely. Kawneer does not control the selection of product configurations, operating hardware, or glazing materials, and assumes no responsibility therefor.

Kawneer reserves the right to change configuration without prior notice when deemed necessary for product improvement.
 © 2013, Kawneer Company, Inc.

NOTE: For standard storefront applications the outrigger is limited to 30".
Details shown with 30" square outrigger, arch blade and rectangular fascia.

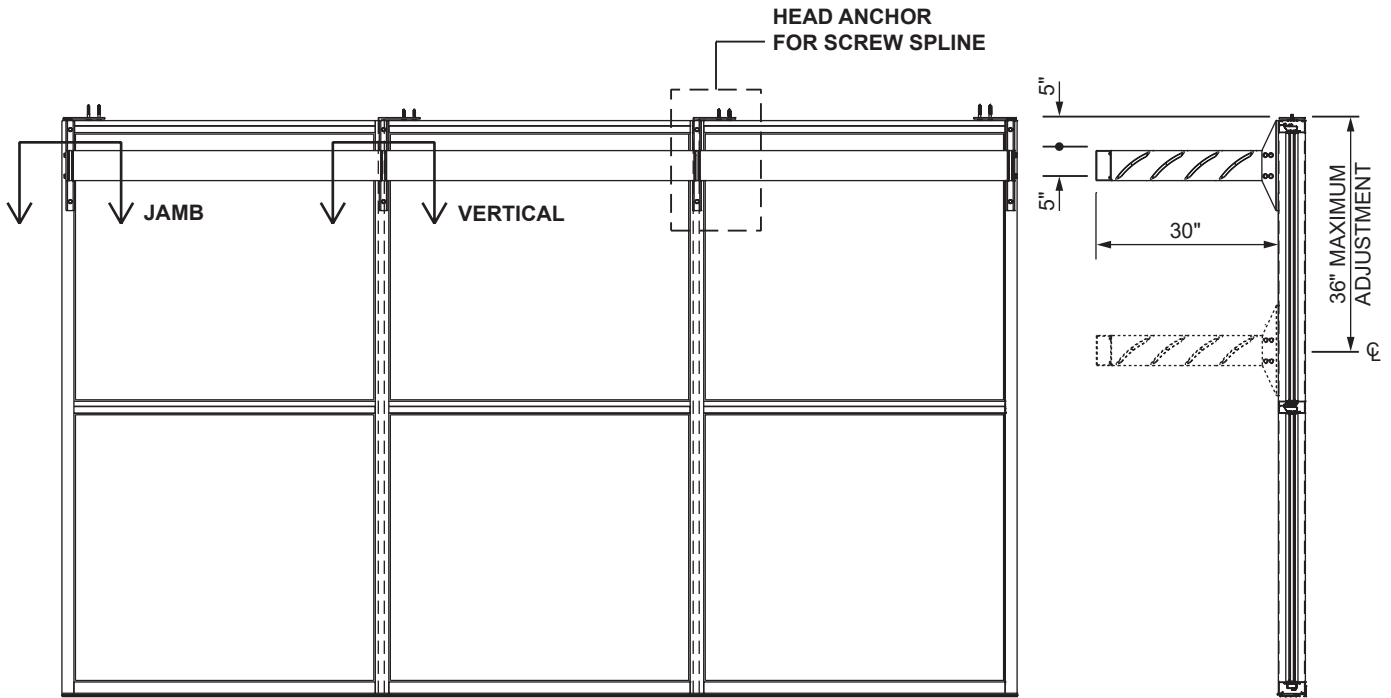

NOTE:
Horizontal SunShades are not recommended directly over entrances and walkways to eliminate any risk of injury due to falling ice or snow.

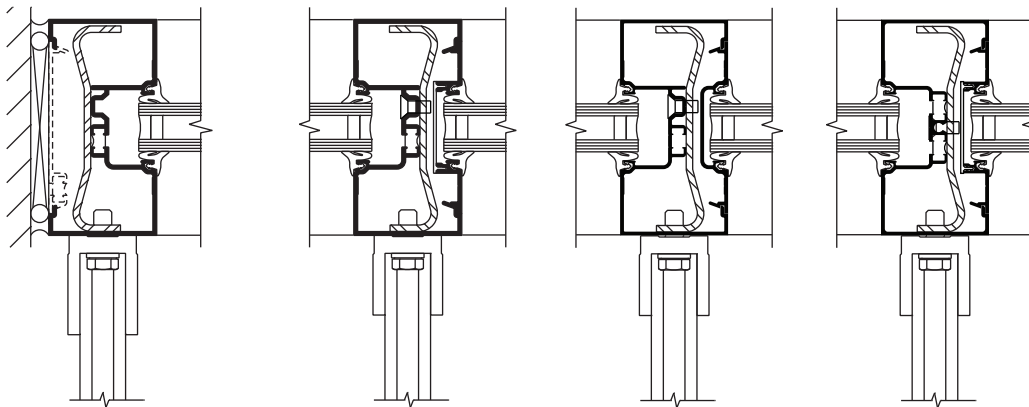

**TRIFAB® VG 451T
JAMB
(TF VG 451 & 451UT
SIMILAR)**

**451T
VERTICAL**

**451
VERTICAL**

**451UT
VERTICAL**

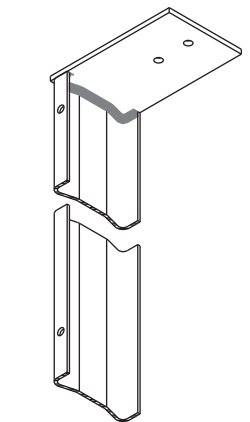

**HEAD ANCHOR FOR
SCREW SPLINE
FRAMING**

Laws and building and safety codes governing the design and use of Kawneer products, such as glazed entrance, window, and curtain wall products, vary widely. Kawneer does not control the selection of product configurations, operating hardware, or glazing materials, and assumes no responsibility therefor.

Kawneer reserves the right to change configuration without prior notice when deemed necessary for product improvement.
© 2013, Kawneer Company, Inc.

NOTE: For standard storefront applications the outrigger is limited to 30".
 Details shown with 30" square outrigger, arch blade and rectangular fascia.

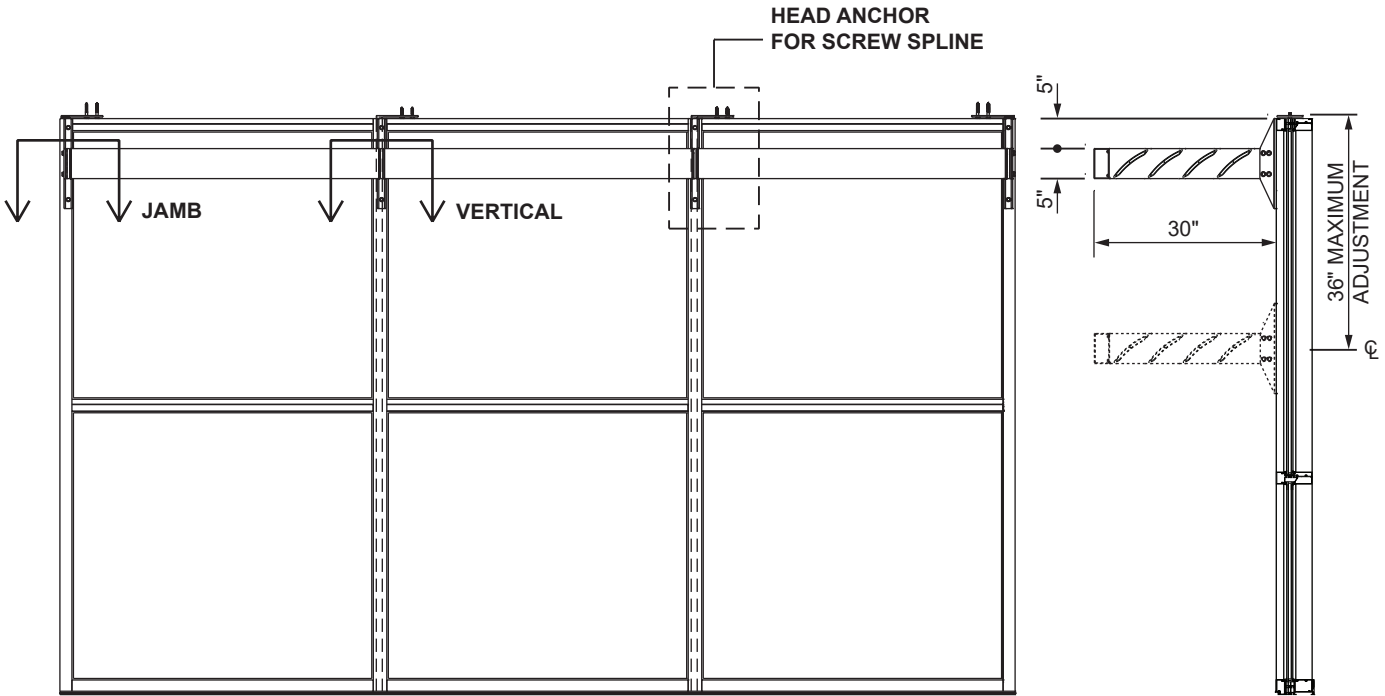

NOTE:
 Horizontal SunShades are not recommended directly over entrances and walkways to eliminate any risk of injury due to falling ice or snow.

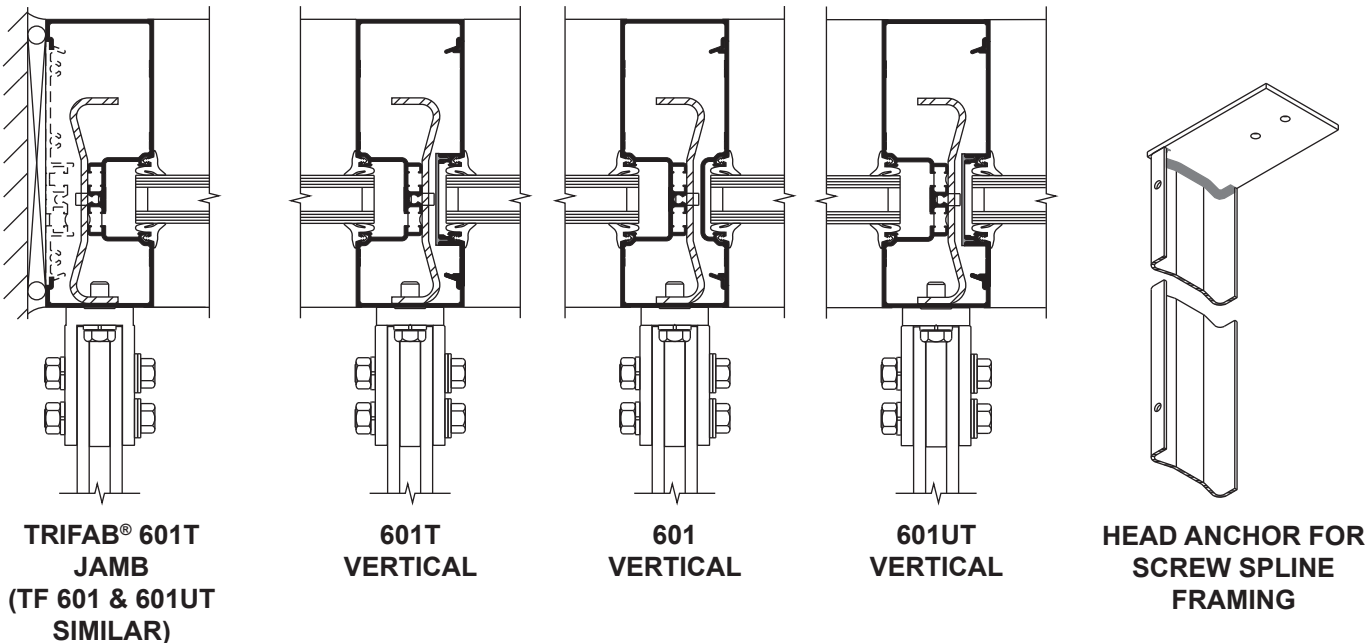

















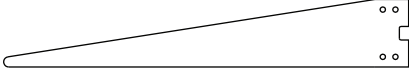













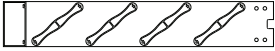
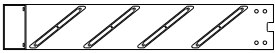

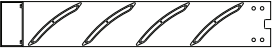
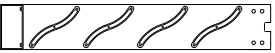

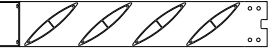
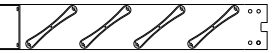

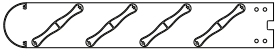
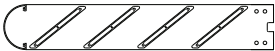
Laws and building and safety codes governing the design and use of Kawneer products, such as glazed entrance, window, and curtain wall products, vary widely. Kawneer does not control the selection of product configurations, operating hardware, or glazing materials, and assumes no responsibility therefor.

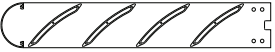
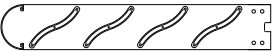
Kawneer reserves the right to change configuration without prior notice when deemed necessary for product improvement.
 © 2013, Kawneer Company, Inc.

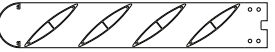
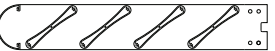
Laws and building and safety codes governing the design and use of Kawneer products, such as glazed entrance, window, and curtain wall products, vary widely. Kawneer does not control the selection of product configurations, operating hardware, or glazing materials, and assumes no responsibility therefor.

Kawneer reserves the right to change configuration without prior notice when deemed necessary for product improvement.
© 2013, Kawneer Company, Inc.

STANDARD OUTRIGGERS	STANDARD FASCIAS	STANDARD BLADES	
 <p>30" SQUARE</p>	 <p>RECTANGULAR</p>	 <p>INFINITY</p>	 <p>FLARE</p>
 <p>30" ROUNDED</p>	 <p>BULLNOSE</p>	 <p>ARCH</p>	 <p>CIRCULAR</p>
 <p>30" WEDGE</p>	 <p>ANGULAR</p>	 <p>AIRFOIL</p>	 <p>DIAMOND</p>
 <p>30" CURVED</p>	 <p>PLANAR</p>	 <p>WAVE</p>	 <p>SQUARE</p>
	 <p>CIRCULAR</p>	 <p>CIRCULAR</p>	 <p>CIRCULAR</p>
		 <p>DIAMOND</p>	 <p>SQUARE</p>

<p>30" SQUARE OUTRIGGER</p>	 <p>INFINITY</p>  <p>PLANAR</p>  <p>CIRCULAR</p>	 <p>ARCH</p>  <p>WAVE</p>  <p>DIAMOND</p>	 <p>AIRFOIL</p>  <p>FLARE</p>  <p>SQUARE</p>
<p>30" ROUNDED OUTRIGGER</p>	 <p>INFINITY</p>  <p>PLANAR</p>  <p>CIRCULAR</p>	 <p>ARCH</p>  <p>WAVE</p>  <p>DIAMOND</p>	 <p>AIRFOIL</p>  <p>FLARE</p>  <p>SQUARE</p>
<p>30" CURVED OUTRIGGER</p>	 <p>DIAMOND</p>  <p>SQUARE</p>  <p>CIRCULAR</p>		
<p>30" WEDGE OUTRIGGER</p>	 <p>CIRCULAR</p>		

Laws and building and safety codes governing the design and use of Kawneer products, such as glazed entrance, window, and curtain wall products, vary widely. Kawneer does not control the selection of product configurations, operating hardware, or glazing materials, and assumes no responsibility therefor.

Kawneer reserves the right to change configuration without prior notice when deemed necessary for product improvement.
© 2013, Kawneer Company, Inc.

PRODUCT NOTES:

1. Maximum outrigger projection for storefront framing should not exceed 30".
2. Anchors are painted only, and can be painted to match anodized finishes.
Louvers and fascias can be painted or anodized.
3. Standard outriggers, louvers and fascias can be mixed and matched at the designers choosing.
4. Some modification or customization of standard components can be accommodated.
Please contact your Kawneer Representative for assistance.
5. Due to the wide variety of building codes, load restrictions, and deflection criteria, the use of SunShades on storefront should be analyzed and approved by Kawneer Application Engineers on a project specific basis.
6. If Versoleil® SunShade does not meet your aesthetic or performance needs, please contact your Kawneer Representative for assistance in designing a custom sunshade.

Laws and building and safety codes governing the design and use of Kawneer products, such as glazed entrance, window, and curtain wall products, vary widely. Kawneer does not control the selection of product configurations, operating hardware, or glazing materials, and assumes no responsibility therefor.

Kawneer reserves the right to change configuration without prior notice when deemed necessary for product improvement.
© 2013, Kawneer Company, Inc.